

Supplement to CCM.D-K4 ”Hydrometer” report: Linkage of EURAMET.M.D-K4 comparison, SIM.M.D-K4 comparison and the supplementary SIM.M.D-S2 to CCM.D-K4 “Hydrometer”

S. Lorefice¹ and L.O. Becerra²

¹ Istituto Nazionale di Ricerca Metrologica (INRiM), Strada delle Cacce, 91; 10135 Torino, ITALY

² Centro Nacional de Metrologia (CENAM), Km 4.5 Carretera a los Cués, Mpio El Marqués, Querétaro – MEXICO

Abstract

Evaluation of different types of comparisons to a common set of Reference Values of a CIPM Key Comparison is essential to satisfy the concept of the CIPM Mutual Recognition Arrangement (CIPM MRA), where the *DoEs* of any participant who took part in comparisons should be within the Calibration and Measurement Capability (CMC) section of the CIPM MRA Key Comparison Data Base. The subject of this supplement report is therefore to present the equivalence of each National metrological institute (NMI) participant in the CCM.D-K4 “Hydrometer” key comparison, which was performed in the density range 600 kg/m^3 to 2000 kg/m^3 at the temperature of $20 \text{ }^\circ\text{C}$, and the linkage of the European and Inter-American NMI results performed in the RMO.M.D-K4 comparisons as well as those of the supplementary SIM.M.D-S2 to the common set of *KCRVs* of the CCM.D-K4 “Hydrometer”.

The linking procedure has been obtained by numerical simulation, based on Monte Carlo method, in which the differences in the results of the different comparison between the intended laboratory and one or more linking laboratory/ies, which took part in both comparisons, are correlated with a continuous function describing the *DoEs* of the linking laboratory/ies with respect to the common set of *KCRVs* of the CCM.D-K4.

Contents:

1. Introduction	3
2. Methodology	5
2.1 The linking procedure	5
2.2 Numerical simulation by Monte Carlo method	6
3. Experimental	7
3.1 The link laboratory/ies in “hydrometer” comparisons	7
3.2.1 Linkage of A and B CCM.D-K4 petals respect to the common set of <i>KCRVs</i>	10
3.2.2 Linkage of RMO.M.D-K4 comparisons to CCM.D-K4 “Hydrometer”	11
4. Discussion and Conclusion	12
Acknowledgements	14
Reference	14
Appendix	16

1. Introduction

Different kinds of technical comparisons in “Hydrometry” have been performed everywhere among many National metrology institutes (NMIs) since the mid of 90s, according to the increased requirement of traceability in the density field. Each participants and different calibration laboratories improved in the meanwhile their own experimental setups and updated their calibration methods for supporting appropriately the Calibration and Measurement Capabilities (CMCs entries) in the context of the CIPM MRA [1, 2].

In the period 2003 – 2011, thirty-four (34) National metrological institutes (NMIs) took part in three different comparisons supported by the related RMOs in the density range 600 kg/m^3 to 1300 kg/m^3 by using a set of high resolution hydrometers of L10 and L20 type for liquid density (scale unit 0.1 kg/m^3 and 0.2 kg/m^3 , respectively), followed by the supplementary bilateral comparison SIM.M.D-S2 in the density range of 800 kg/m^3 to 1000 kg/m^3 at $20 \text{ }^\circ\text{C}$ [3, 4, 5].

In the period 2011 – 2013, under the auspice of the CCM Working Group on Density (now WG-Density & Viscosity), a CIPM key comparison with eleven (11) participants from each regional metrology organization was performed as CCM-D-K4 “Hydrometer” concerning the calibration of high resolution hydrometers for liquid density determinations in the range 600 kg/m^3 to 2000 kg/m^3 at the temperature of $20 \text{ }^\circ\text{C}$ [6].

Table 1 shows the NMI participants in the CCM.D-K4 key comparison, in the Regional key comparison EURAMET.M.D-K4 and SIM.M.D-K4 and finally in the supplementary comparison SIM.M.D-S2.

The purpose of this work is to present the results to be published in Appendix B of the KCDB of BIPM concerning the linkage of Group A and Group B of the CCM.D-K4 comparison and the linking of the results of the international measurement comparisons related to hydrometers performed in the EURAMET and SIM area to the CCM.D-K4 comparison.

In the first part, the paper is focused on assessing the linking laboratory/ies and in computing for each of them the link functions (regression curve as a function of density), which fits the individual *DoEs* with respect to the CCM.D-K4 key comparison reference values with associated uncertainties.

The following step was the numerical simulation by Monte Carlo method for determining, for each NMI to be linked, its degrees of equivalence (*DoEs*) with respect to the CCM.D-K4 reference values together with its associated uncertainty.

Table 1. Details of the NMI participants in the EURAMET, SIM and CCM.D-K4 comparisons concerning hydrometer calibration. The participants KRISS (KR), NMIA (AUS) and NMIJ(JP) took part in the CCM.D-K4 comparisons on behalf of APMP. The bold crosses are for pilot and co-pilot NMI.

NMI	CCM.D-K4	EURAMET.M.D-K4	SIM.M.D-K4	SIM.M.D-S2
INRiM - Italy	X	X		X
MKEH (ex OMH) - Hungary	X	X		
PTB - Germany	X	X		
LNE France	X	X		
IPQ - Portugal	X	X		
VTT - MIKES - Finland		X		
BEV – Austria		X		
UME - Turkey		X		
GUM - Poland	X	X		
SMU - Slovakia		X		
VNIIM - Russia		X		
CENAM - Mexico	X		X	
BSJ - Jamaica			X	
CENAMEP - Panama			X	
CESMEC - Chile			X	
IBMETRO - Bolivia			X	
INDECOPI - Peru			X	
INEN - Ecuador			X	
INMETRO - Brazil			X	X
INTI - Argentina			X	
LACOMET - Costa Rica			X	
LATU - Uruguay	X		X	
NIST - United States of America	X		X	
NRC - Canada			X	
SIC - Colombia			X	
KRISS – Korea (the Republic of)	X			
NMIJ - Japan	X			
NMIA - Australia	X			

2. Methodology

2.1 The linking procedure

In many comparisons, a set of *DoEs* is calculated for each participant, representing its own measurement capability on a whole specific measurement range. For any participant in the key comparison, a regression curve, obtained by means of weighted least squares (WLS) method, can be used for modelling the set of the *DoEs* with their uncertainties (linking function) in all measuring range [6, 7]. Such curve is a continuous counterpart of the key comparison reference values (*KCRVs*) in the domain of the key comparison, currently determined from the measured data at each density value. Moreover the chi-square statistic χ^2 or, equivalently, the reduced chi-square statistic (chi-square per degrees of freedom) $\tilde{\chi}^2$ (i.e., the Birge ratio), can be also used as indicators of the agreement between the observed and the predicted *DoEs*, as well as between the estimated variance of the fit and the uncertainties associated to the *DoEs*.

In the framework of the CCM.D-K4 key comparison, for each linking laboratory $l_k = 1, \dots, f < n$ (where n is the number of the participants of comparison to be linked), a straight line curve was used for fitting the *DoEs* $D_{l_k}(\rho_i)$ corresponding to the nominal density values ρ_i in the density range 600 to 2000 kg/m³

$$D_{l_k}(\rho_i) = m_{l_k} \rho_i + b_{l_k} + \varepsilon_i, \quad (1)$$

where ρ_i is the independent quantity value in the measurement range ($i = 1, \dots, R$, with R equal to the number of the points (observations) in the key comparison). This equation involves two parameters to be estimated for each laboratory l_k : the slope (m_{l_k}) and the intercept (b_{l_k}) of the regression line.

The procedure yields to a set of R equations which, written in matrix notation, become

$$\mathbf{D}_{l_k} = \boldsymbol{\rho} \boldsymbol{\beta}_{l_k} + \mathbf{E} \quad (2)$$

where \mathbf{D}_{l_k} is the ($R \times 1$) column vector of the degrees of equivalence of l_k the linking laboratory, $\boldsymbol{\rho}$ is the ($R \times 2$) design matrix (its first column containing the R tested nominal values of density and its second column being a column of ones), \mathbf{E} is the ($R \times 1$) vector of random errors or disturbances and, $\boldsymbol{\beta}_{l_k}$ is the (2×1) column vector which contains the slope m_{l_k} and the intercept b_{l_k} of the regression straight line.

The best estimate of the parameter vector $\boldsymbol{\beta}_{l_k}$ is given by

$$\hat{\boldsymbol{\beta}}_{l_k} = \left(\boldsymbol{\rho}_{l_k}^T \boldsymbol{\Psi}_{D_{l_k}}^{-1} \boldsymbol{\rho}_{l_k} \right)^{-1} \boldsymbol{\rho}_{l_k}^T \boldsymbol{\Psi}_{D_{l_k}}^{-1} \mathbf{D}_{l_k} \quad (3)$$

where the weighting matrix $\boldsymbol{\Psi}_{D_{l_k}}$ is the variance-covariance matrix of the *DoEs* of laboratory l_k at the ρ_i density values in the measurement range. A correlation coefficient of 0.9 can be assumed for *DoEs* corresponding to nominal densities measured by same tested hydrometer, whereas a correlation coefficient of 0.3 for *DoEs* corresponding to the nominal densities measured by different tested hydrometers.

The term $\boldsymbol{\Psi}_{l_k} = \left(\boldsymbol{\rho}_{l_k}^T \boldsymbol{\Psi}_{D_{l_k}}^{-1} \boldsymbol{\rho}_{l_k} \right)^{-1}$ is assumed to be the variance-covariance matrix of the best fit parameters $\hat{\boldsymbol{\beta}}_{l_k}$ concerning the linking laboratory l_k .

A measure of goodness-of-fit of model (2) to the measurement results is given by the reduced chi-squared statistic $\tilde{\chi}^2 = \frac{\chi^2}{\nu} = \frac{\left(\mathbf{D}_{l_k} - \boldsymbol{\rho} \hat{\boldsymbol{\beta}}_{l_k} \right)^T \boldsymbol{\Psi}_{D_{l_k}}^{-1} \left(\mathbf{D}_{l_k} - \boldsymbol{\rho} \hat{\boldsymbol{\beta}}_{l_k} \right)}{\nu} \leq 1$, where ν is the number of degrees of freedom, given by $R - p$, where R and p are the number of observations and the number of fitted parameters, respectively (in the considered case, $p = 2$).

Therefore, the predicted *DOEs* are:

$$\hat{\mathbf{D}}_{l_k} = \boldsymbol{\rho} \hat{\boldsymbol{\beta}}_{l_k} \quad (4)$$

Each degree of equivalence of laboratory B with respect to the related *KCRV* is then determined through the continuous function of the linking laboratory and the degree of equivalence between pairs of laboratories $d'_{B,l_k}(\rho_j)$ calculated at each nominal value ρ_j measured in the bilateral comparison ($j=1, \dots, R'$) in the density range included in the domain of the linking function:

$$\begin{aligned} D_B(\rho_j) &= d'_{B,l_k}(\rho_j) + \hat{D}_{l_k}(\rho_j) = \left(X'_B(\rho_j) - X'_{l_k}(\rho_j) \right) + \hat{D}_{l_k}(\rho_j) = \\ &= \left(X'_B(\rho_j) - X'_{l_k}(\rho_j) \right) + \left(\hat{m}_{l_k} \cdot \rho_j + \hat{b}_{l_k} \right) \end{aligned} \quad (5)$$

with associated square uncertainty

$$u_{D_B}^2(\rho_j) = u_{X'_B}^2(\rho_j) + u_{X'_{l_k}}^2(\rho_j) + u_{D_{l_k}}^2(\rho_j) - 2 \cdot u \left(X'_{l_k}(\rho_j), \hat{D}_{l_k}(\rho_j) \right). \quad (6)$$

2.2 Numerical simulation by Monte Carlo method

The individual degree of equivalence with respect to the CIPM reference value $D_r(\rho_j)$ of the $r = n - l_k$ participants that did take part in RMOs comparisons, whose results need to be linked

to the common set of *KCRVs*, can be evaluated also by numerical simulation using the Monte Carlo method (MC) involving random sampling from appropriate probability distributions.

The numerical simulation was done by a commercial software package able to run in Excel 2010, with 1×10^5 trials (@Risk 7.5 – Palisade). The software deals with normally distributed input quantities appropriately combined, taking into account the possible correlations and run random simulations on the various scenarios. From the resulting probability density function (pdf) of the numerical simulation, the mean value was taken as the best estimate for the *DoE* of the participant laboratory at each tested density value, and the standard deviation was taken as the standard uncertainty of such result. However, in practice, more linking laboratories are involved in the linking process, so that, the degrees of equivalence of laboratory B with respect to the *KCRVs* have been determined through the average of the continuous function of the linking laboratories l_k ($l_k = 1, \dots, f$) calculated at each nominal value ρ_j of the bilateral comparisons ($j = 1, \dots, R'$) in the density range included in the domain ρ of the linking function:

$$D_B(\rho_j) = \frac{\sum_{l_k, j} (d'_{B, l_k}(\rho_j) + \hat{D}_{l_k}(\rho_j))}{l_k}. \quad (7)$$

Figure 1 shows the diagram concerning the simulation process which involves the propagation of the input quantities with their associated uncertainties to provide the distribution of the output quantities by using the model defined by the equation (7).

Figure 2 shows an example of graphical representation of the pdf for the individual degree of equivalence with respect to CIPM reference value, together with the numerical results of the simulation.

3. Experimental

3.1 The link laboratory/ies in “hydrometer” comparisons

The CIPM key comparison referred to as CCM.D-K4 “Hydrometer” covered the calibration capability of high resolution hydrometers for liquid and alcoholometers in the density range 600 kg/m^3 to 2000 kg/m^3 at the temperature of $20 \text{ }^\circ\text{C}$. Nine NMIs other than INRiM, CENAM and PTB took part in the comparison, divided in two groups (petals A and B). Two similar sets of three high accuracy hydrometers for liquid density determinations (type L10 – scale division: 0.1 kg/m^3 and L20 - scale division: 0.2 kg/m^3) and an alcoholometer (cl. 1) were each one assigned at each petal and circulated as travelling standards. Each hydrometer was

Figure 1. Diagram concerning the numerical simulation using the Monte Carlo method; The laboratory B measurements $X'_B(\rho_j)$ made in the RMOs comparison, the measurements of the link laboratory/ies $X'_{l_k}(\rho_j)$ in the RMOs comparison and the DoEs $\hat{D}_k(\rho_j)$ resulting from linking function at the nominal density value j with the associated uncertainties $u_{X'_B}(\rho_j)$, $u_{X'_{l_k}}(\rho_j)$ and $u_{\hat{D}_k}(\rho_j)$ are the input quantities. The individual degree of equivalence with respect to the CIPM reference value $\hat{D}_B(\rho_j)$ of the participant B that didn't took part in CIPM key comparison and its uncertainty $u_{\hat{D}_B}(\rho_j)$ are the simulation results.

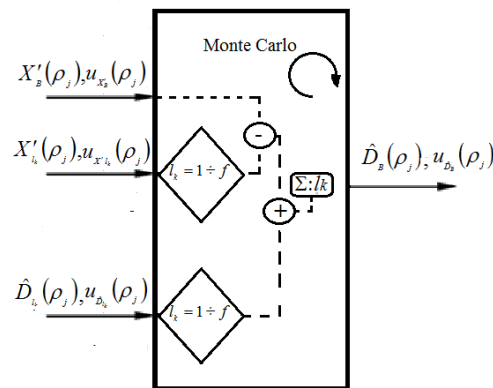
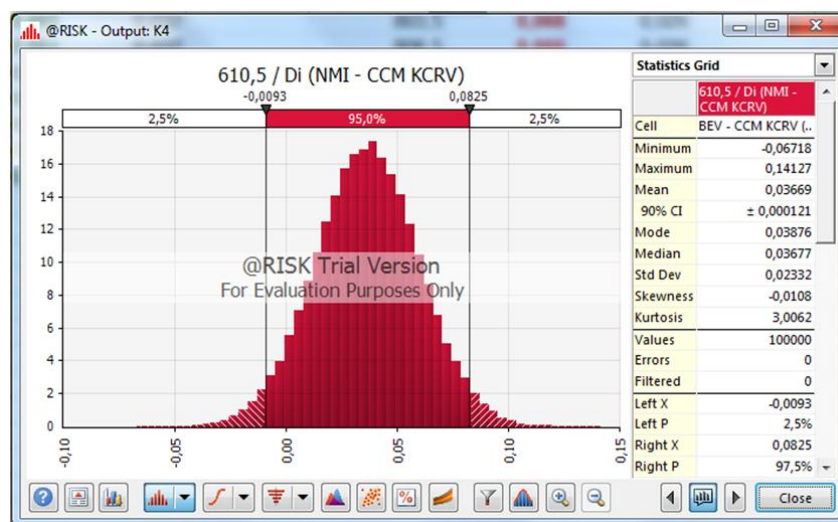

Figure 2 Graphical representation of the pdf for the individual degree of equivalence with respect to the CIPM reference value and numerical results of the simulation.



calibrated at three density values of the scale; twelve results were submitted from each participants to the pilot laboratory. All NMI participants of CCM.D-K4 can be suitable to serve as a link laboratory in the RMO and supplementary comparisons after the results of all NMI in the two petals were conformed to a common set of Reference Values of a CIPM Key Comparison.

Table 2. Normalized errors E_n in the density sub-range (i.e., degrees of equivalence $d_{k,h}$ between pair of laboratories over their expanded uncertainty), concerning the INRiM, CENAM and PTB who measured all the Transfer Standards of CCM.D-K4.

Division of the scale 0.1 kg/m³ in the density sub-range 600 kg/m³ and 1500 kg/m³.

Division of the scale 0.2 kg/m³ in the density sub-range 1980 kg/m³ and 2000 kg/m³.

	Range / kg/m ³	E_n		
		INRiM-CENAM	INRiM-PTB	CENAM-PTB
Petal A	600 - 610	0.5	0.2	0.3
	986 - 997	0.4	0.5	0.1
	1490 - 1500	0.3	0.2	0.2
	1980 - 2000	0.3	0.3	0.2
Petal B	600 - 610	0.1	0.1	0.0
	986 - 997	0.3	0.2	0.5
	1490 - 1500	0.0	0.3	0.2
	1980 - 2000	0.1	0.7	0.6

The three Institutes INRiM, CENAM and PTB proved the skill and capability in the liquid density measurements and hydrometer calibrations in previous participation in RMOs comparisons, in addition showing no significant differences in the results of the calibration of all transfer standards in both petals A and B of the CCM.D-K4 (Table 2) [6]. Therefore the linking function from the $DoEs$ calculated for each of the three NMIs is a valuable reference to make the linkage of any other NMI results to the common set of $KCRVs$ of the CCM.D-K4 in the tested density range.

In Table 3 the estimated parameters of the regression curve (1) calculated according to equation (3) in the domain between 600 kg/m³ and 2000 kg/m³ are shown for each of the three institutes designed as link laboratories for linking the RMO.M.D-K4 comparisons to the CCM.D-K4 “Hydrometer”. Table also reports the reduced chi-squared values $\tilde{\chi}^2$.

Link NMI	\hat{m}_{i_k}	$u(\hat{m}_{i_k})$	\hat{b}_{i_k} kg/m ³	$u(\hat{b}_{i_k})$ kg/m ³	$\tilde{\chi}^2$
INRiM	-2,03E-06	5E-06	-0,002	0,005	0,4
CENAM	6,90E-07	6E-06	0,002	0,006	0,2
PTB	7,89E-06	4E-06	-0,005	0,005	0,4

Table 3. Estimated parameters of the regression curve (6) in the domain between 600 kg/m³ and 2000 kg/m³, calculated according to equation (8) for each of the three institutes INRiM, CENAM and PTB designed as “link” laboratories for linking the RMO.M.D-K4 comparisons to the CCM.D-K4 “Hydrometer”. Table reports also the uncertainties of the parameters and the $\tilde{\chi}^2$ values.

3.2.1 Linkage of A and B CCM.D-K4 petals respect to the common set of KCRVs

The linkage between the NMI results of both two petals A and B respect to the common set of CCM.D-K4 reference values has been established as well as outlined in section 3.7 of [6]. In order that the set of individual degree of equivalence with the corresponding uncertainty are estimated by simulation for any NMI participant q , the differences between the measurements of participant and the measurements of the three linking laboratories INRiM, CENAM and PTB performed in the respective petal at the tested densities in addition to the *DoEs* resulting from the linking functions with the respective uncertainties are the input quantities for the numerical simulation.

The current linking of the results of A and B petals with respect to the common set of KCRVs of CCM.D-K4 key comparison are reported in the Appendix relating to each sub-range of density.

Tables report the estimated *DoEs*, $\hat{D}_q(\rho_i)$ with respect to the common set of *KCRVs* and its uncertainty at a 95 % of confidence level of each NMI as they result from the numerical simulation at any tested density value ρ_i ($i = 1, \dots, R$, with R equal to the number of the points (observations) in the key comparison at each tested density value. For any NMI the tables also

report the arithmetic mean on the three degree of equivalence $\Delta_q = \frac{\sum_i \hat{D}_q(\rho_i)}{3}$ corresponding to the same tested hydrometer with the estimated expanded uncertainty

$$U_{\Delta_q} = 2 \left[\left(u_{\Delta_q}^2(\rho_i) \right) + \frac{(\hat{D}_{q\max} - \hat{D}_{q\min})^2}{12} \right]^{\frac{1}{2}}$$

which takes also into account the reproducibility in the calibration of the laboratory by assuming a rectangular distribution on the sub-range of the individual degrees of equivalence with respect to the three *KCRVs* for each transfer standard. Moreover in the last column are shown the results of the consistency test $\Delta_q \leq 2u(\Delta_q)$, according to the key comparisons rule. In Appendix are also shown the graphs of equivalence of NMI participants in the CCM.D-K4 at each tested sub-range of the nominal liquid density with the corresponding expanded uncertainties ($k = 2$).

Figure 3 resumes the equivalence of the NMIs involved in the petal A and B, respectively linked to the common set of *KCRVs* obtained for the CCM.D-K4 “Hydrometer”. The figure shows the equivalences in the different tested sub-ranges of the nominal liquid density with the corresponding expanded uncertainties ($k = 2$) related to each NMI participant.

Figure 3. Graph of equivalence obtained for the CCM.D-K4 “Hydrometer” in the different tested sub-ranges of liquid density. Error bars indicate expanded uncertainties ($k = 2$).

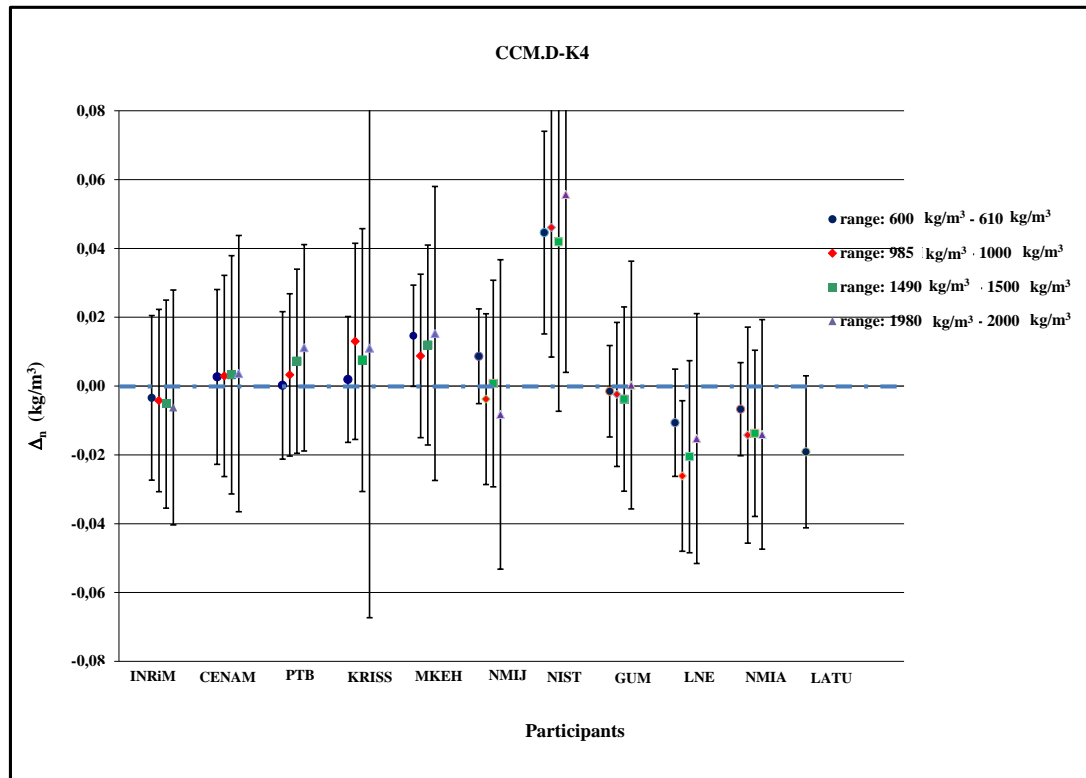

3.2.2 Linkage of RMO.M.D-K4 comparisons to CCM.D-K4 “Hydrometer”

This section concerns with the linkage to CCM.D-K4 key comparison of the regional key comparisons EUROMET.M.D-K4 (project 702) and SIM.M.D-K4 as well as of bilateral supplementary comparison SIM.M.D-S2 which followed the two regional key comparisons.

The EUROMET.M.D-K4 (project 702) and SIM.M.D-K4 regional key were performed with the main aim to check the stated uncertainty levels and the degrees of equivalence of NMI participating laboratories for hydrometer calibrations in the density range between 600 kg/m³ and 1300 kg/m³ at 20 °C and to check liquid density measuring instruments used for this purpose.

Few differences could be noticed between the two regional key comparisons in their organization, including, in particular, the number of participants (Table 1), the range of the supplied hydrometers and the number of nominal density values for which the participants had to report the density corrections and the associated uncertainties. Nevertheless, the link procedure can be applied unchanged: each result of the European laboratories which took part in the EUROMET.M.D-K4 has been linked to the common set of *KCRVs* of the CCM.D-K4

key comparison by resorting to the link functions of the INRiM and PTB and to the differences between the individual measurements of each participant and the measurements of the two linking laboratories made in the regional comparison at each tested density value. In the same way, each result of the NMIs from all SIM sub-regions participating in the SIM.M.D-K4 has been linked to the *KCRVs* of the CCM.D-K4 key comparison by resorting to the link function of the CENAM and to the differences between the individual measurements of each participant and the measurement of the linking laboratory made in the regional comparison at each tested density value. Finally the results of the SIM.M.D-S2 bilateral supplementary comparison between INMETRO and INRiM, which followed the two regional key comparisons for hydrometer calibrations in the density range between 800 kg/m^3 and 1000 kg/m^3 at $20 \text{ }^\circ\text{C}$, have been linked to the *KCRVs* of the CCM.D-K4 key comparison by resorting to the link function of the INRiM and to the differences between the individual measurements of both participants in the supplementary comparison at each tested density value.

The current linking of the participant results of the RMOs key and supplementary comparisons with respect to the common set of *KCRVs* of CCM.D-K4 key comparison are reported in the Appendix relating to each sub-range of density. The tables report the individual *DoEs* of the NMIs as provided by the simulation with their uncertainties at a 95 % level of confidence, and the arithmetic means Δ_n of the three (four) degrees of equivalence corresponding with the expanded uncertainties $U(\Delta_n)$ determined for the range of each tested hydrometer. The last column shows the result of the consistency test, too. In Appendix are also shown the equivalence graphs for each density sub range.

As an example, Figure 4 shows the three sets of the NMI degrees of equivalence with respect to the common set of CCM.D-K4 reference values concerning the sub-ranges $600 - 620 \text{ kg/m}^3$ (a), and $985 - 1010 \text{ kg/m}^3$ (b).

4. Discussion and Conclusion

The degree of equivalence with respect to reference value of any different types of comparison are the results used to support the CMC claims of each NMI. Moreover they provide information, giving evidence on the NMI ability to produce results as required by the specification, on the typical repeatability and reproducibility as well as on the environmental sources of uncertainty for the intended measurements [8].

In the present paper, a practical method has been applied for conforming the results of the European and Inter-American NMI results performed in the RMO.M.D-K4 comparisons as

Figure 4. NMI degrees of equivalence with respect to the common set of CCM.D-K4 reference values concerning the sub-ranges 600 - 620 kg/m³ (a), and 985 – 1010 kg/m³ (b). Error bars indicate expanded uncertainties ($k = 2$).

Blue diamonds: participants in CCM.D-K4.

Red squares: participants in EURAMET.M.D-K4.

Green triangles: participants in SIM.M.D-K4

Braun squares: participants in SIM.M.D-S2

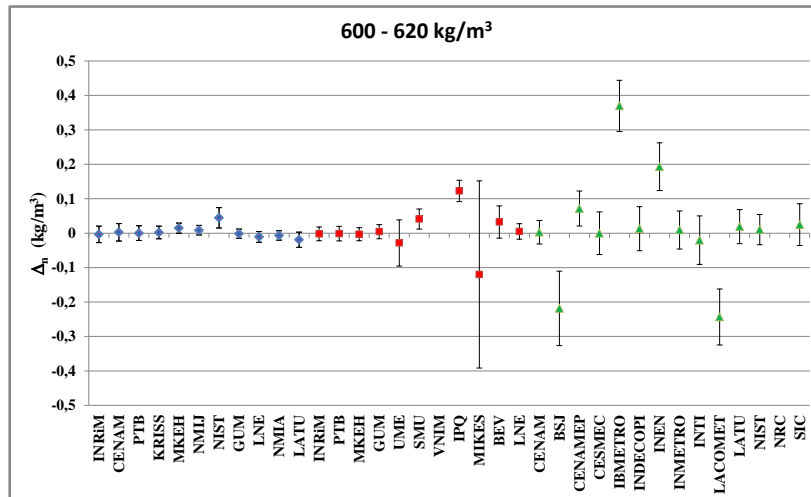

a)

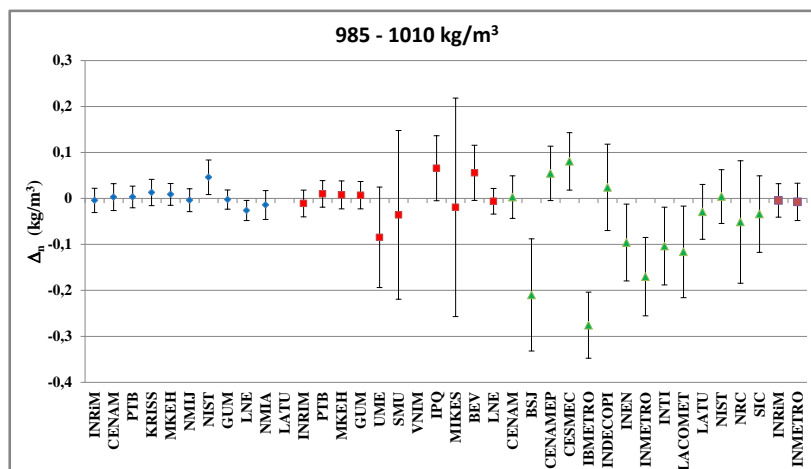

b)

well as those of the supplementary comparison SIM.M.D-S2 to the common set of *KCRVs* of the CCM.D-K4 “Hydrometer”. The linking procedure has been obtained by numerical simulation, based on Monte Carlo method, in which the differences in the results of the different comparison between the intended laboratory and one or more linking laboratory/ies, which took part in both comparisons, are correlated with a continuous function describing the *DoEs* of the linking laboratory/ies with respect to the common set of *KCRVs* of the

CCM.D-K4. INRiM (Italy), CENAM (Mexico) and PTB (Germany) were deemed suitable to be the linkage laboratories, having showed similar repeatability performances in all the past performed exercises.

The linking procedure has clearly proved to work well, allowing to evaluate the capabilities to be listed in the Calibration and Measurement Capability (CMC) section of the CIPM MRA Key Comparison Data Base for any participant who took part in comparisons and to give evidence of the comparability between institutes that could have not participated in all the exercises. It was also revealed that the values and uncertainties claimed by each NMI laboratory were not significantly modified by the linkage. Some NMIs took part in at least two comparisons, showing instead several degrees of equivalence quite different among the comparisons. Although only those obtained in the CCM.D-K4 should be retained, all results may be regarded as further information about the performance of the laboratory in its own calibration activity which should be taken into account in the laboratory uncertainty claimed for the CMC. Moreover, some laboratory have shown inconsistent results. This should suggest to investigate the causes and to apply all the appropriate corrective actions including supplementary comparison to verify. In particular, their capabilities in hydrometer calibration and in liquid measurements are strongly restricted, at the moment they are not compliant with the choice of the user of hydrometers, where the maximum permissible errors associated to the instrument allow to be traceable and used as standard in the sub-field of density [9].

Acknowledgements

The authors would like to express their deepest gratitude to Dr Francesca Pennechi from INRiM for her assistance with the statistics and useful critiques of this research work.

References

- [1] CIPM MRA, available at: <http://www.bipm.org/en/cipm-mra/cipm-mra-text/>.
- [2] CMCs: Calibration and Measurement Capabilities information available at: <http://kcdb.bipm.org/>.
- [3] S Lorefice et al “EUROMET.M.D-K4/EUROMET Project 702: Comparison of the calibrations of high-resolution hydrometers for liquid density determinations”, Metrologia, 2008, 45, Tech. Suppl., 07008, 2008, 41 pages.

- [4] L O Becerra “Final report of comparison of the calibrations of hydrometers for liquid density determination between SIM laboratories: SIM.M.D-K4”, *Metrologia*, 2009, 46, Tech. Suppl., 07007.
- [5] S Lorefice, D Malta, J J Pinheiro, P R Marteleto “Bilateral comparison on the calibrations of hydrometers for liquid density between INRIM-Italy and INMETRO-Brazil: SIM.M.D-S2”, *Metrologia*, Volume 47, Technical Supplement, pp. 07011 (2010) <http://iopscience.iop.org/article/10.1088/0026-1394/47/1A/07011>.
- [6] S Lorefice et al. CCM key comparison CCM.D-K4 “Hydrometer” *Metrologia*, Volume 53, Technical Supplement 2016 <http://iopscience.iop.org/article/10.1088/0026-1394/53/1A/07003>.
- [7] L O. Becerra, S Lorefice and F Pennechi “Hydrometers calibration: linking SIM NMIs to the Euramet key comparison reference value of EURAMET.M.D-K4” *Ingeniería* 22 (2) 2012: 95-105, ISSN: 1409-2441;. San José, Costa Rica.
- [8] ISO/IEC 17025:2005 “General requirements for the competence of testing and calibration laboratories”, ISO –Switzerland.
- [9] ISO 649-1:1981 “Laboratory glassware – Density hydrometers for general purposes” Part 1: specification.

Appendix

This section deals with the results of the numerical simulation concerning the Degrees of Equivalence for any NMI with respect to a common set of the CCM.D.K-4 “Hydrometer” key comparison reference values (*KCRVs*) with the related uncertainty at the 95 % of confidence level at the nominal measured density values. Moreover, the arithmetic means Δ_n of the three (four) degrees of equivalence corresponding with the expanded uncertainties $U(\Delta_n)$ determined for the range of each tested hydrometer are listed and showed for each NMI. The result of the consistency test is given, too.

In particular the section concerns with:

Tables A1 to A4 and Figures A1 to A4 related to the linkage of petals A and B results to a common set of the CCM.D.K-4 “Hydrometer” key comparisons reference values.

Tables A5 to A8 and Figures A5 to A8 related to the linkage of RMO comparisons results to a common set of the CCM.D.K-4 “Hydrometer” key comparisons reference values.

Table A1. Estimated degree of equivalence DoE of the NMI participating in the CCM.D.K-4 key comparison to the common set of $KCRVs$ of the CCM.D.K-4 with the expanded uncertainty at each tested density nominal value and average of the corresponding estimated DoE in the density sub-range 600 to 610 kg/m^3 .

kg/m^3	ρ_i	601,0		605,0		609,0		range: 600 kg/m^3 - 610 kg/m^3		
		$\bar{D}_q(\rho_i)$	$U_{\bar{D}_q}(\rho_i)$	$\bar{D}_q(\rho_i)$	$U_{\bar{D}_q}(\rho_i)$	$\bar{D}_q(\rho_i)$	$U_{\bar{D}_q}(\rho_i)$	Δ_q	$U(\Delta_q)$	$ \Delta_q \leq U(\Delta_q)$
NMI	kg/m^3	kg/m^3	kg/m^3	kg/m^3	kg/m^3	kg/m^3	kg/m^3	kg/m^3	kg/m^3	
INRiM	-0,003	0,024	-0,003	0,024	-0,003	0,024	-0,003	0,024	V	
CENAM	0,003	0,025	0,003	0,025	0,003	0,025	0,003	0,025	V	
PTB	0,000	0,021	0,000	0,021	0,000	0,021	0,000	0,021	V	
KRISS	0,005	0,018	0,002	0,018	-0,001	0,018	0,002	0,018	V	
MKEH	0,021	0,014	0,013	0,014	0,010	0,014	0,015	0,015	V	
NMIJ	0,005	0,014	0,009	0,014	0,011	0,014	0,009	0,014	V	
NIST	0,051	0,029	0,043	0,029	0,040	0,029	0,045	0,029	X	
GUM	-0,003	0,013	-0,002	0,013	0,001	0,013	-0,002	0,013	V	
LNE	-0,014	0,015	-0,010	0,015	-0,008	0,015	-0,011	0,016	V	
NMIA	-0,003	0,013	-0,007	0,013	-0,010	0,013	-0,007	0,014	V	
LATU	-0,019	0,022	-0,019	0,022	-0,020	0,022	-0,019	0,022	V	

Figure A1. Equivalence of each CCM.D-K4 NMI participant with respect to the common set of $KCRVs$ of CCM.D-K4 in the density sub-range 600 to 610 kg/m^3 .

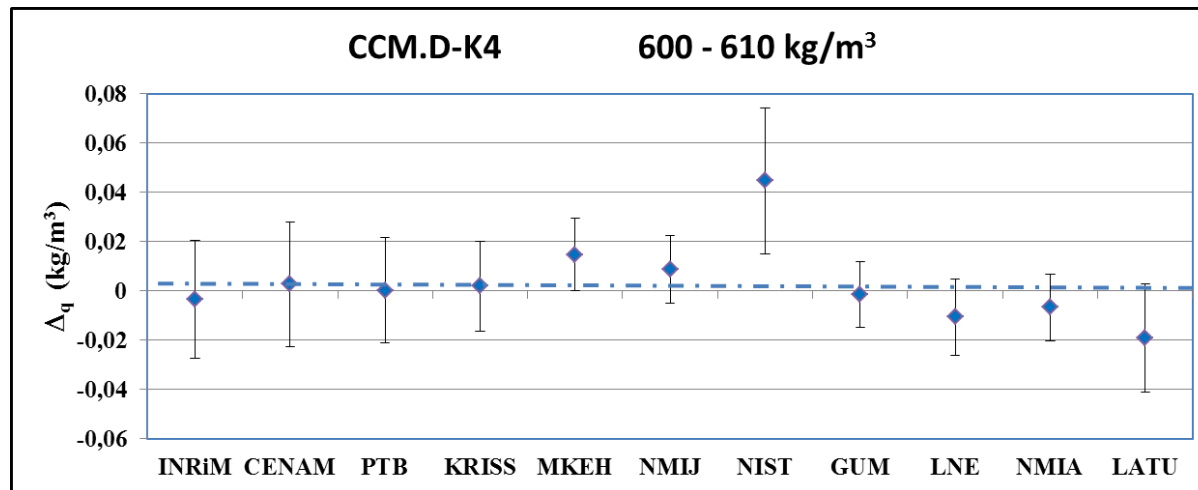

Table A2. Estimated degree of equivalence *DoE* of the NMI participating in the CCM.D.K-4 key comparison to the common set of *KCRVs* of the CCM.D.K-4 with the expanded uncertainty at each tested density nominal value and average of the corresponding estimated *DoE* in the density sub-range 985 to 1000 kg/m³.

kg/m ³	ρ_i	985,92		991,06		996,70		range: 985 kg/m ³ - 1000 kg/m ³		
		$\hat{D}_q(\rho_i)$ kg/m ³	$U_{\hat{D}_q}(\rho_i)$ kg/m ³	$\hat{D}_q(\rho_i)$ kg/m ³	$U_{\hat{D}_q}(\rho_i)$ kg/m ³	$\hat{D}_q(\rho_i)$ kg/m ³	$U_{\hat{D}_q}(\rho_i)$ kg/m ³	Δ_q kg/m ³	$U(\Delta_q)$ kg/m ³	$ \Delta_q \leq U(\Delta_q)$
INRiM	-0,004	0,026	-0,004	0,027	-0,004	0,027	-0,004	0,026	V	
CENAM	0,003	0,029	0,003	0,029	0,003	0,029	0,003	0,029	V	
PTB	0,003	0,024	0,003	0,024	0,003	0,024	0,003	0,024	V	
KRISS	0,015	0,028	0,003	0,028	0,021	0,028	0,013	0,029	V	
MKEH	0,022	0,022	0,005	0,022	-0,002	0,022	0,009	0,024	V	
NMIJ	-0,001	0,025	-0,010	0,025	-0,001	0,025	-0,004	0,025	V	
NIST	0,044	0,037	0,055	0,037	0,038	0,037	0,046	0,038	X	
GUM	-0,004	0,021	-0,001	0,021	-0,003	0,021	-0,002	0,021	V	
LNE	-0,033	0,021	-0,031	0,021	-0,015	0,021	-0,026	0,022	X	
NMIA	-0,001	0,030	-0,023	0,030	-0,019	0,030	-0,014	0,031	V	
LATU										

Figure A2. Equivalence of each CCM.D-K4 NMI participant with respect to the common set of *KCRVs* of CCM.D-K4 in the density sub-range 985 to 1000 kg/m³.

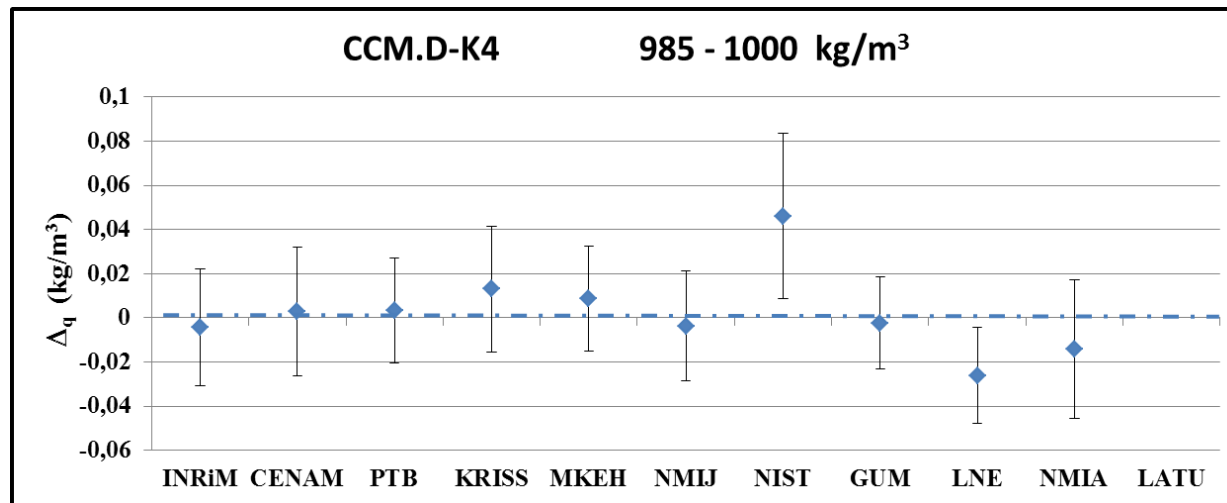

Table A3. Estimated degree of equivalence DoE of the NMI participating in the CCM.D.K-4 key comparison to the common set of $KCRVs$ of the CCM.D.K-4 with the expanded uncertainty at each tested density nominal value and average of the corresponding estimated DoE in the density sub-range 1400 to 1500 kg/m^3 .

kg/m^3	ρ_i	1491,0		1495,0		1499,0		range: 1490 kg/m^3 - 1500 kg/m^3		
		$\bar{D}_q(\rho_i)$ kg/m^3	$U_{\bar{D}_q}(\rho_i)$ kg/m^3	$\bar{D}_q(\rho_i)$ kg/m^3	$U_{\bar{D}_q}(\rho_i)$ kg/m^3	$\bar{D}_q(\rho_i)$ kg/m^3	$U_{\bar{D}_q}(\rho_i)$ kg/m^3	Δ_q kg/m^3	$U(\Delta_q)$ kg/m^3	$ \Delta_q \leq U(\Delta_q)$
	NMI									
	INRiM	-0,005	0,030	-0,005	0,030	-0,005	0,030	-0,005	0,030	V
	CENAM	0,003	0,035	0,003	0,035	0,003	0,035	0,003	0,035	V
	PTB	0,007	0,027	0,007	0,027	0,007	0,027	0,007	0,027	V
	KRISS	0,016	0,038	0,004	0,030	0,002	0,038	0,008	0,038	V
	MKEH	0,024	0,027	0,016	0,027	-0,005	0,027	0,012	0,029	V
	NMIJ	0,011	0,029	-0,005	0,029	-0,003	0,029	0,001	0,030	V
	NIST	0,044	0,049	0,036	0,049	0,045	0,049	0,042	0,049	V
	GUM	-0,005	0,027	-0,005	0,027	-0,001	0,027	-0,004	0,027	V
	LNE	-0,029	0,027	-0,019	0,027	-0,013	0,027	-0,021	0,028	V
	NMIA	-0,007	0,024	-0,016	0,024	-0,019	0,024	-0,014	0,024	V
	LATU									

Figure A3. Equivalence of each CCM.D-K4 NMI participant with respect to the common set of $KCRVs$ of CCM.D-K4 in the density sub-range 1490 to 1500 kg/m^3 .

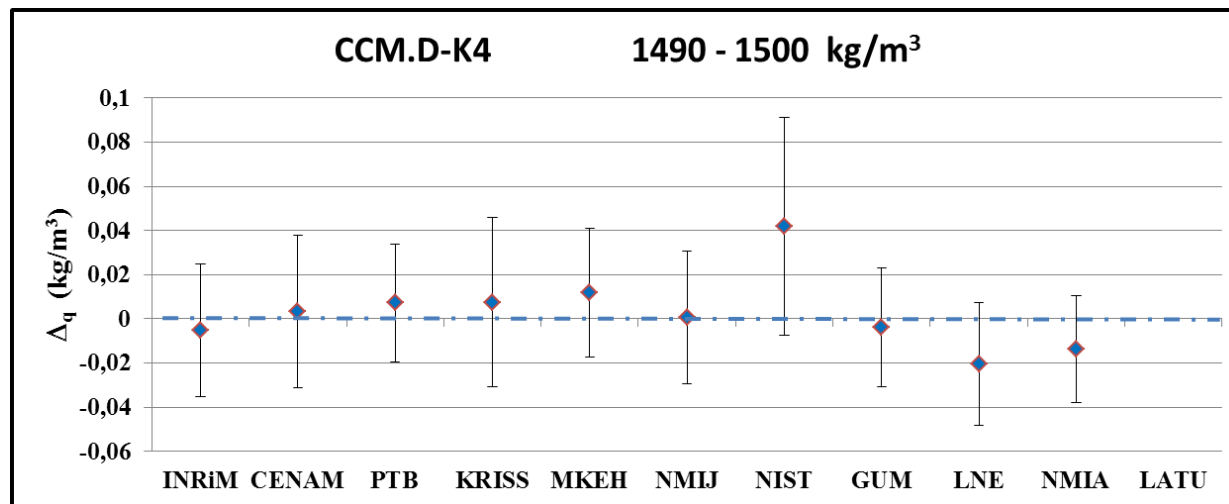

Table A4. Estimated degree of equivalence DoE of the NMI participating in the CCM.D.K-4 key comparison to the common set of $KCRVs$ of the CCM.D.K-4 with the expanded uncertainty at each tested density nominal value and average of the corresponding estimated DoE in the density sub-range 1980 to 2000 kg/m^3 .

kg/m^3	ρ_i	1981,0		1990,0		1999,0		range: 1980 kg/m^3 - 2000 kg/m^3		
		$\hat{D}_q(\rho_i)$ kg/m^3	$U_{\hat{D}_q}(\rho_i)$ kg/m^3	$\hat{D}_q(\rho_i)$ kg/m^3	$U_{\hat{D}_q}(\rho_i)$ kg/m^3	$\hat{D}_q(\rho_i)$ kg/m^3	$U_{\hat{D}_q}(\rho_i)$ kg/m^3	Δ_q kg/m^3	$U(\Delta_q)$ kg/m^3	$ \Delta_q \leq U(\Delta_q)$
INRiM	-0,006	0,034	-0,006	0,034	-0,006	0,034	-0,006	0,034	V	
CENAM	0,004	0,040	0,004	0,040	0,004	0,040	0,004	0,040	V	
PTB	0,011	0,030	0,011	0,030	0,011	0,030	0,011	0,030	V	
KRISS	0,022	0,078	0,008	0,052	0,003	0,052	0,011	0,078	V	
MKEH	0,044	0,035	0,017	0,035	-0,015	0,035	0,015	0,043	V	
NMIJ	0,005	0,044	-0,010	0,044	-0,019	0,044	-0,008	0,045	V	
NIST	0,045	0,050	0,047	0,072	0,075	0,072	0,056	0,052	X	
GUM	-0,009	0,035	0,006	0,036	0,004	0,036	0,000	0,036	V	
LNE	-0,021	0,036	-0,017	0,036	-0,008	0,036	-0,015	0,036	V	
NMIA	-0,005	0,033	-0,020	0,033	-0,017	0,033	-0,014	0,033	V	
LATU										

Figure A4. Equivalence of each CCM.D-K4 NMI participant with respect to the common set of $KCRVs$ of CCM.D-K4 in the density sub-range 1990 to 2000 kg/m^3 .

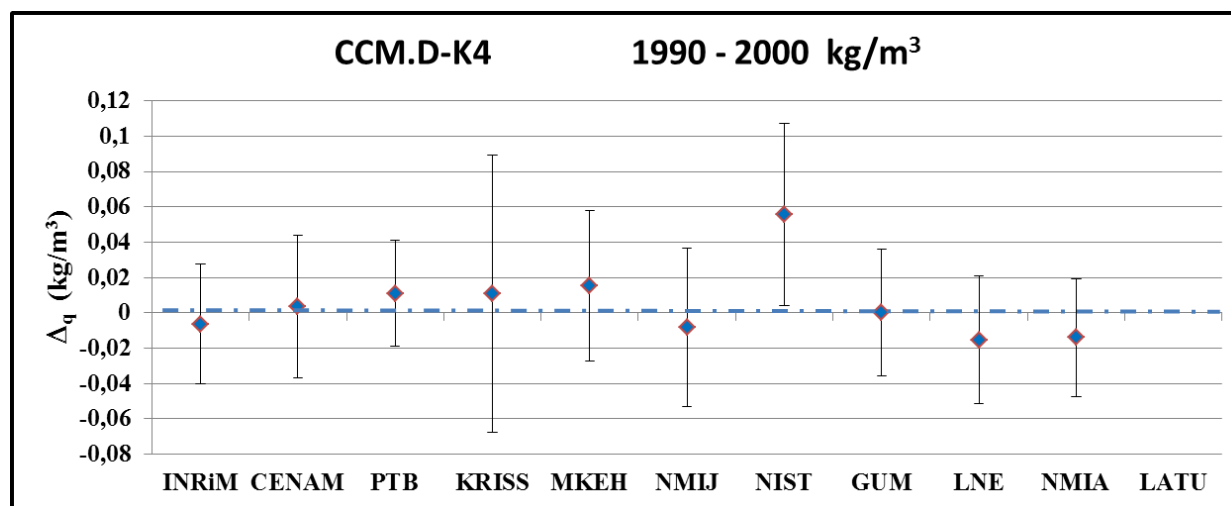

Table A5. Estimated degree of equivalence *DoE* of the NMI participating in the RMO key comparisons EURAMET.M.D.K-4 and SIM.M.D.K-4 to the common set of *KCRVs* of the CCM.D.K-4 with the expanded uncertainty at each tested density nominal value and average of the corresponding estimated *DoE* in the density sub-range 600 to 620 kg/m³.

	kg/m ³	ρ_j	600,5		601,0		603,5		605,0		606,5		609,0		609,5		610,5		613,5		616,5		619,5		range: 600 kg/m ³ - 620 kg/m ³				
			$\bar{D}_n(\rho_j)$	$U_{\bar{D}_n}(\rho_j)$	$\bar{D}_n(\rho_j)$	$U_{\bar{D}_n}(\rho_j)$	$\bar{D}_n(\rho_j)$	$U_{\bar{D}_n}(\rho_j)$	$\bar{D}_n(\rho_j)$	$U_{\bar{D}_n}(\rho_j)$	$\bar{D}_n(\rho_j)$	$U_{\bar{D}_n}(\rho_j)$	$\bar{D}_n(\rho_j)$	$U_{\bar{D}_n}(\rho_j)$	$\bar{D}_n(\rho_j)$	$U_{\bar{D}_n}(\rho_j)$	$\bar{D}_n(\rho_j)$	$U_{\bar{D}_n}(\rho_j)$	$\bar{D}_n(\rho_j)$	$U_{\bar{D}_n}(\rho_j)$	$\bar{D}_n(\rho_j)$	$U_{\bar{D}_n}(\rho_j)$	$\bar{D}_n(\rho_j)$	$U_{\bar{D}_n}(\rho_j)$	$\bar{D}_n(\rho_j)$	$U_{\bar{D}_n}(\rho_j)$	Δ_n	$U(\Delta_n)$	$ \Delta_n \leq U(\Delta_n)$
NMI	kg/m ³	kg/m ³	kg/m ³	kg/m ³	kg/m ³	kg/m ³	kg/m ³	kg/m ³	kg/m ³	kg/m ³	kg/m ³	kg/m ³	kg/m ³	kg/m ³	kg/m ³	kg/m ³	kg/m ³	kg/m ³	kg/m ³	kg/m ³	kg/m ³	kg/m ³	kg/m ³	kg/m ³	kg m ⁻³	kg m ⁻³			
EURAMET.M.D.K-4	INRM	-0,001	0,020			-0,003	0,020			-0,003	0,020			-0,002	0,020	-0,002	0,020	-0,003	0,020	-0,002	0,020	-0,001	0,020	-0,002	0,020	-0,002	0,020	V	
	PTB	-0,002	0,021			-0,001	0,021			0,000	0,021			-0,001	0,021	-0,001	0,021	0,000	0,021	-0,001	0,021	-0,002	0,021	-0,002	0,021	-0,001	0,021	V	
	MKEH	0,002	0,019			-0,006	0,019			-0,007	0,019			-0,008	0,019	0,003	0,019	-0,001	0,019	-0,004	0,019	-0,002	0,019	-0,003	0,019	-0,003	0,019	V	
	GUM	0,007	0,020			0,002	0,020			0,004	0,020			0,005	0,020													V	
	UME	-0,024	0,067			-0,030	0,067			-0,030	0,067			-0,029	0,067													V	
	SMU	0,042	0,029			0,043	0,029			0,041	0,029			0,039	0,029													X	
	VNIM																												
	IPQ														0,117	0,030	0,139	0,030	0,115	0,030	0,120	0,030	0,122	0,031	0,122	0,031	X		
	MIKES														-0,123	0,272	-0,121	0,271	-0,115	0,272	-0,120	0,272	-0,120	0,272	-0,120	0,272	-0,120	0,272	V
	BEV														0,037	0,047	0,029	0,047	0,035	0,047	0,030	0,047	0,032	0,047	0,032	0,047	0,032	0,047	V
LNE														-0,001	0,022	0,002	0,022	0,009	0,022	0,009	0,022	0,005	0,023	0,005	0,023	0,005	0,023	V	
SIM.M.D.K-4	CENAM			0,003	0,030			0,003	0,031			0,003	0,034														0,003	0,034	V
	BSJ			-0,265	0,080			-0,314	0,081			-0,075	0,083														-0,218	0,108	X
	CENAMEP			0,069	0,046			0,071	0,046			0,074	0,051														0,072	0,051	X
	CESMEC			0,000	0,058			-0,002	0,059			0,001	0,062														0,000	0,062	V
	IBMETRO			0,340	0,068			0,358	0,069			0,411	0,072														0,370	0,074	X
	INDECOPI			0,010	0,060			0,018	0,061			0,011	0,064														0,013	0,064	V
	INEN			0,140	0,062			0,218	0,062			0,221	0,065														0,193	0,069	X
	INMETRO			-0,035	0,043			0,002	0,043			0,060	0,048														0,009	0,055	V
	INTI			-0,010	0,067			-0,022	0,067			-0,029	0,070														-0,020	0,070	V
	LACOMET			-0,275	0,075			-0,213	0,075			-0,243	0,079														-0,243	0,081	X
	LATU			0,030	0,045			0,013	0,045			0,014	0,049														0,019	0,049	V
	NIST			0,010	0,038			0,006	0,038			0,014	0,044														0,010	0,044	V
	NRC																												
SIC			0,007	0,056			0,018	0,056			0,049	0,060														0,025	0,061	V	

Figure A5. Equivalence of each RMO.M.D-K4 NMI participant with respect to the common set of *KCRVs* of CCM.D-K4 in the density sub-range 600 to 620 kg/m³.

Blue diamonds: participants in EURAMET.M.D-K4.

Red squares: participants in SIM.M.D-K4.

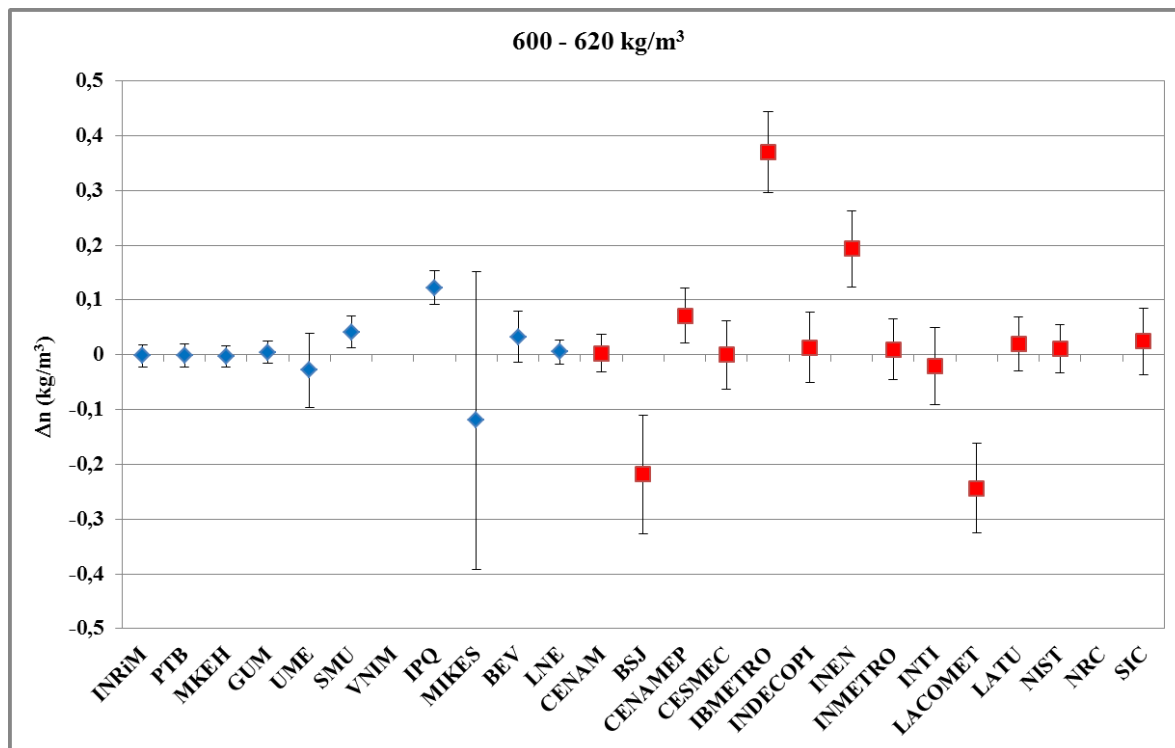

Figure A6. Equivalence of each RMO.M.D-K4 NMI participant with respect to the common set of *KCRVs* of CCM.D-K4 in the density sub-range 800 to 820 kg/m³.

Blue diamonds: participants in EURAMET.M.D-K4.

Red squares: participants in SIM.M.D-K4.

Green triangles: participants in SIM.M.D-S2,

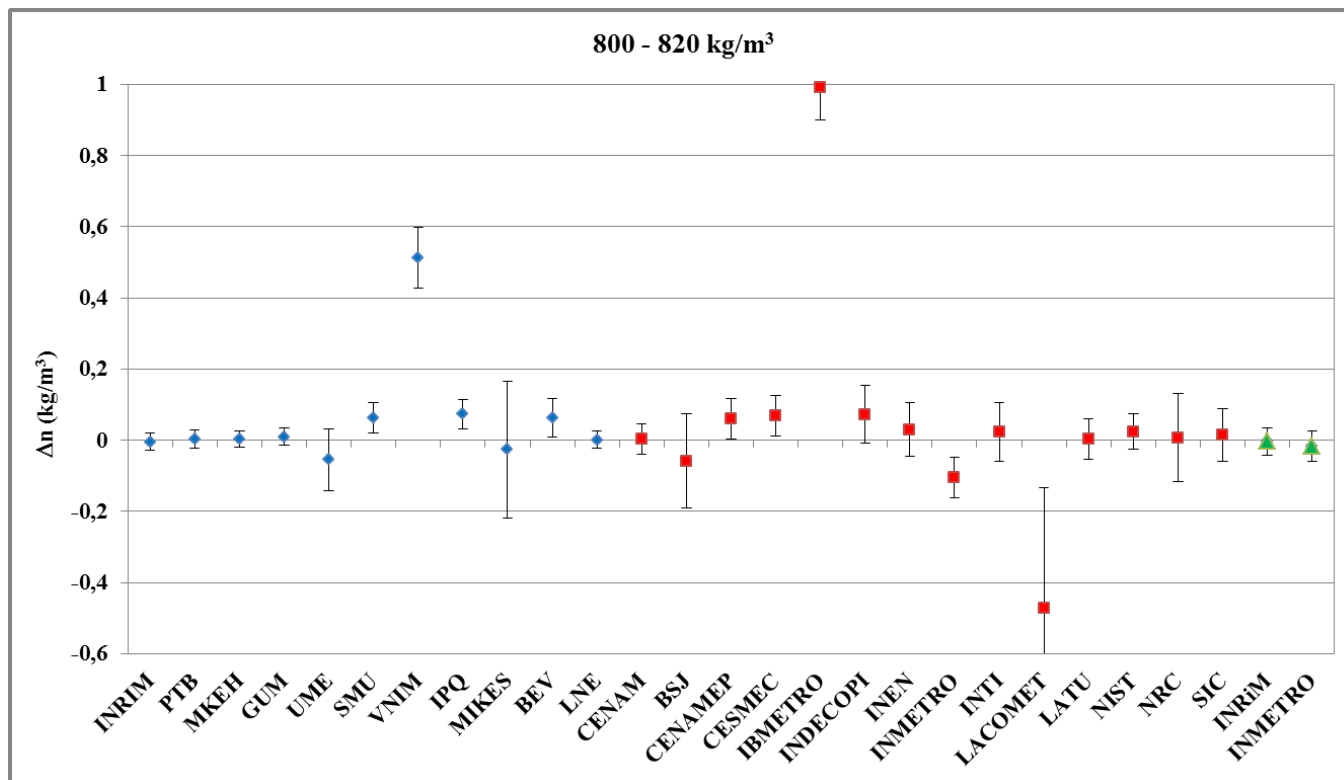

Table A7. Estimated degree of equivalence *DoE* of the NMI participating in the RMO key comparisons EURAMET.M.D.K-4 and SIM.M.D.K-4 and supplementary comparisons SIM.M.D.S2 to the common set of *KCRVs* of the CCM.D.K-4 with the expanded uncertainty at each tested density nominal value and average of the corresponding estimated *DoE* in the density sub-range 990 to 1010 kg/m³.

	kg/m ³	ρ_j	990,5		991,0		993,5		995,0		996,5		999,0		999,5		1000,5		1003,5		1006,5		1009,5		range: 990 kg/m ³ - 1010 kg/m ³					
			$\bar{D}_n(\rho_j)$	$U_{\bar{D}_n}(\rho_j)$	$\bar{D}_n(\rho_j)$	$U_{\bar{D}_n}(\rho_j)$	$\bar{D}_n(\rho_j)$	$U_{\bar{D}_n}(\rho_j)$	$\bar{D}_n(\rho_j)$	$U_{\bar{D}_n}(\rho_j)$	$\bar{D}_n(\rho_j)$	$U_{\bar{D}_n}(\rho_j)$	$\bar{D}_n(\rho_j)$	$U_{\bar{D}_n}(\rho_j)$	$\bar{D}_n(\rho_j)$	$U_{\bar{D}_n}(\rho_j)$	$\bar{D}_n(\rho_j)$	$U_{\bar{D}_n}(\rho_j)$	$\bar{D}_n(\rho_j)$	$U_{\bar{D}_n}(\rho_j)$	$\bar{D}_n(\rho_j)$	$U_{\bar{D}_n}(\rho_j)$	$\bar{D}_n(\rho_j)$	$U_{\bar{D}_n}(\rho_j)$	$\bar{D}_n(\rho_j)$	$U_{\bar{D}_n}(\rho_j)$	Δ_n	$U(\Delta_n)$	$ \Delta_n \leq U(\Delta_n)$	
NMI	kg/m ³	kg/m ³	kg/m ³	kg/m ³	kg/m ³	kg/m ³	kg/m ³	kg/m ³	kg/m ³	kg/m ³	kg/m ³	kg/m ³	kg/m ³	kg/m ³	kg/m ³	kg/m ³	kg/m ³	kg/m ³	kg/m ³	kg/m ³	kg/m ³	kg/m ³	kg/m ³	kg/m ³	kg/m ³	kg/m ³	kg/m ³	kg/m ³	kg/m ³	kg/m ³
EURAMET.M.D.K-4	INRIM	-0,009	0,029			-0,008	0,029			-0,007	0,029			-0,005	0,029	-0,007	0,029	-0,015	0,029	-0,016	0,029	-0,020	0,029			-0,011	0,029	V		
	PTB	0,008	0,029			0,007	0,029			0,006	0,029			0,004	0,029	0,006	0,029	0,014	0,029	0,015	0,029	0,019	0,029			0,010	0,029	V		
	MKEH	0,011	0,025			0,010	0,025			0,000	0,025			0,003	0,025	0,022	0,029	0,015	0,029	0,005	0,030	-0,005	0,030			0,008	0,031	V		
	GUM	0,001	0,029			0,003	0,028			0,009	0,028			0,015	0,028												0,007	0,030	V	
	UME	-0,090	0,109			-0,095	0,109			-0,076	0,109			-0,078	0,109												-0,085	0,109	V	
	SMU	-0,070	0,183			-0,040	0,182			-0,028	0,182			-0,006	0,182												-0,036	0,184	V	
	VNIM																													
	IPQ															0,073	0,071	0,068	0,071	0,062	0,034	0,060	0,071			0,066	0,071	V		
	MIKES															-0,053	0,235	-0,067	0,236	-0,010	0,235	0,053	0,236			-0,019	0,238	V		
	BEV															0,067	0,060	0,053	0,060	0,050	0,060	0,053	0,060			0,056	0,060	V		
	LNE															-0,013	0,028	0,000	0,028	-0,006	0,028	-0,006	0,028			-0,006	0,028	V		
SIM.M.D-K4	CENAM			0,003	0,044			0,003	0,046			0,003	0,045													0,003	0,046	V		
	BSI			-0,137	0,099			-0,306	0,101			-0,187	0,099													-0,210	0,122	X		
	CENAMEP			0,056	0,056			0,060	0,059			0,047	0,057													0,055	0,059	V		
	CESMEC			0,091	0,059			0,076	0,062			0,075	0,060													0,081	0,063	X		
	IBMETRO			-0,255	0,067			-0,284	0,070			-0,289	0,069													-0,276	0,072	X		
	INDECOPI			0,051	0,089			0,026	0,091			-0,005	0,090													0,024	0,094	V		
	INEN			-0,159	0,069			-0,074	0,072			-0,055	0,070													-0,096	0,084	X		
	INMETRO			-0,195	0,060			-0,229	0,063			-0,087	0,061													-0,170	0,085	X		
	INTI			-0,093	0,081			-0,099	0,084			-0,119	0,082													-0,104	0,085	X		
	LACOMET			-0,106	0,090			-0,074	0,092			-0,169	0,090													-0,116	0,100	X		
	LATU			-0,030	0,056			-0,031	0,060			-0,027	0,057													-0,029	0,060	V		
	NIST			0,004	0,055			-0,001	0,058			0,009	0,056													0,004	0,059	V		
	NRC			-0,051	0,131			-0,032	0,132			-0,070	0,131													-0,051	0,133	V		
SIC			-0,009	0,079			-0,051	0,081			-0,042	0,080													-0,034	0,083	V			
SIM.M.D-S2	INRIM	-0,004	0,036			-0,004	0,036			-0,004	0,036			-0,004	0,036											-0,004	0,036	V		
	INMETRO	-0,009	0,041			-0,008	0,041			-0,007	0,041			-0,005	0,041											-0,007	0,041	V		

Figure A7. Equivalence of each RMO.M.D-K4 NMI participant with respect to the common set of *KCRVs* of CCM.D-K4 in the density sub-range 990 to 1010 kg/m³.

Blue diamonds: participants in *EURAMET.M.D-K4*.

Red squares: participants in *SIM.M.D-K4*.

Green triangles: participants in *SIM.M.D-S2*.

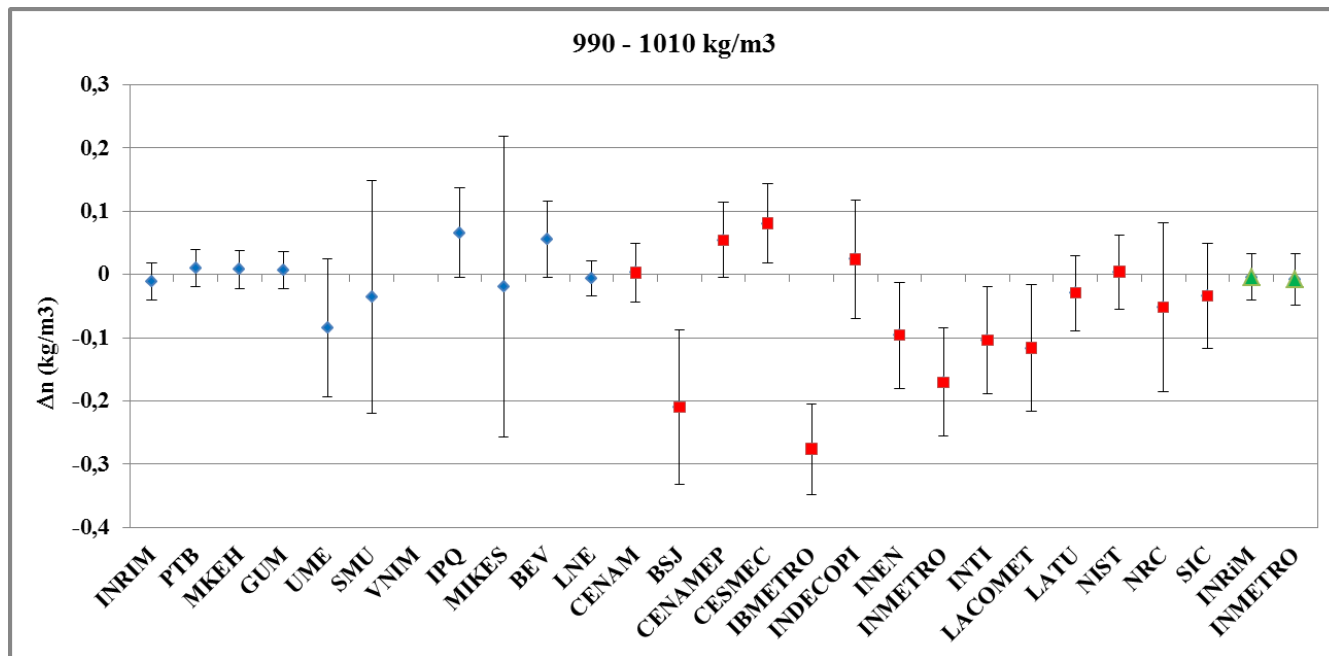

Table A8. Estimated degree of equivalence DoE of the NMI participating in the RMO key comparisons EURAMET.M.D.K-4 and SIM.M.D.K-4 to the common set of $KCRVs$ of the CCM.D.K-4 with the expanded uncertainty at each tested density nominal value and average of the corresponding estimated DoE in the density sub-range 1290 to 1300 kg/m^3 .

	kg/m ³	ρ_j		1290,5		1291,0		1293,5		1295,0		1296,5		1299,0		1299,5		range: 1290 kg/m ³ - 1300 kg/m ³			
		$\bar{D}_n(\rho_j)$	$U_{\bar{D}_n}(\rho_j)$	$\bar{D}_n(\rho_j)$	$U_{\bar{D}_n}(\rho_j)$	$\bar{D}_n(\rho_j)$	$U_{\bar{D}_n}(\rho_j)$	$\bar{D}_n(\rho_j)$	$U_{\bar{D}_n}(\rho_j)$	$\bar{D}_n(\rho_j)$	$U_{\bar{D}_n}(\rho_j)$	$\bar{D}_n(\rho_j)$	$U_{\bar{D}_n}(\rho_j)$	$\bar{D}_n(\rho_j)$	$U_{\bar{D}_n}(\rho_j)$	$\bar{D}_n(\rho_j)$	$U_{\bar{D}_n}(\rho_j)$	Δ_n	$U(\Delta_n)$	$ \Delta_n \leq U(\Delta_n)$	
NMI	kg/m ³	kg/m ³	kg/m ³	kg/m ³	kg/m ³	kg/m ³	kg/m ³	kg/m ³	kg/m ³	kg/m ³	kg/m ³	kg/m ³	kg/m ³	kg/m ³	kg/m ³	kg/m ³	kg/m ³	kg/m ³	kg/m ³	kg/m ³	
EURAMET.M.D.K-4	INRiM	-0,019	0,035			-0,014	0,035			-0,015	0,035			-0,012	0,035			-0,015	0,035	V	
	PTB	0,020	0,032			0,015	0,032			0,016	0,032			0,013	0,032			0,016	0,032	V	
	GUM	0,035	0,032			0,020	0,032			-0,007	0,032			-0,011	0,032			0,009	0,035	V	
		0,010	0,034			0,008	0,034			0,018	0,034			0,025	0,034			0,015	0,034	V	
	UME	-0,128	0,141			-0,133	0,141			-0,128	0,141			-0,108	0,141			-0,124	0,141	V	
	SMU	0,038	0,049			0,040	0,049			0,040	0,049			0,044	0,049			0,041	0,049	V	
	VNIM	-0,093	0,615			-0,086	0,615			-0,064	0,615			-0,035	0,615			-0,069	0,615	V	
	IPQ																				
	MIKES																				
	BEV																				
LNE	-0,007	0,031			-0,005	0,031			0,003	0,031			-0,005	0,031			-0,003	0,031	V		
SIM.M.D-K4	CENAM			0,003	0,044			0,003	0,046			0,003	0,045					0,003	0,046		
	BSJ			-0,140	0,147			-0,140	0,143			-0,147	0,142					-0,142	0,147	V	
	CENAMEP			-0,007	0,077			0,010	0,069			-0,014	0,067					-0,004	0,078	V	
	CESMEC			-0,031	0,077			-0,044	0,073			-0,056	0,070					-0,044	0,077	V	
	IBMETRO																				
	INDECOPI			-0,041	0,112			-0,024	0,109			-0,006	0,107					-0,024	0,112	V	
	INEN			-0,111	0,085			-0,134	0,081			-0,026	0,079					-0,091	0,091	V	
	INMETRO			-0,260	0,089			-0,118	0,082			-0,120	0,080					-0,166	0,098	X	
	INTI			-0,027	0,104			-0,049	0,100			-0,041	0,099					-0,039	0,104	V	
	LACOMET			-0,249	0,097			-0,233	0,090			-0,220	0,089					-0,234	0,098	X	
	LATU			-0,038	0,077			-0,017	0,073			-0,016	0,070					-0,024	0,077	V	
	NIST			-0,016	0,081			0,000	0,073			0,003	0,071					-0,004	0,081	V	
	NRC			-0,080	0,167			-0,073	0,163			-0,093	0,162					-0,082	0,167	V	
SIC			-0,005	0,104			0,029	0,101			0,014	0,099					0,012	0,105	V		

Figure A8. Equivalence of each RMO.M.D-K4 NMI participant with respect to the common set of *KCRVs* of CCM.D-K4 in the density sub-range 1290 to 1300 kg/m³.

Blue diamonds: participants in EURAMET.M.D-K4.

Red squares: participants in SIM.M.D-K4.

